

# Bouclair

**DIRECTIVES D'ASSEMBLAGE**  
**ASSEMBLY INSTRUCTIONS**  
 BUFFET / CABINET  
 SKU 9400411

**IMPORTANT**

- Nous vous suggérons de lire ce dépliant jusqu'au bout et de suivre les instructions simples étape par étape.
- Vérifiez soigneusement que vous avez toutes les pièces avant de commencer l'assemblage.
- Gardez les pièces de fixation hors de la portée des enfants et tenez les enfants bien éloignés de la zone d'assemblage.
- Nous recommandons d'utiliser l'emballage pour protéger les surfaces durant l'assemblage.

**AVERTISSEMENT**











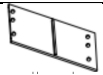
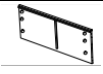
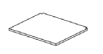
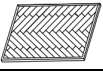
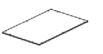



- Manipulez les pièces de bois avec soin durant l'assemblage, car elles peuvent s'égratigner facilement.

**IMPORTANT**

- We suggest you read through this leaflet and follow the simple step-by-step instructions.
- Carefully check that you have all parts before beginning assembly.
- Keep fittings out of children's reach and keep children well away from the assembly area.
- We recommend using the packaging to protect surfaces during assembly.

**WARNING**

Handle wood components with care during assembly as they can scratch easily.

No.	Illustration	Description	QTÉ/QTY	No.	Illustration	Description	QTÉ/QTY
S		Panneau supérieur Top panel	1				
P		Panneau latéral Side panel	2				
R		Panneau du milieu Middle panel	1				
T		Panneau arrière Back panel	2				
X		Porte Door	2				
Q		Panneau d'étagère Shelf panel	2				
O		Panneau inférieur Bottom panel	1				
A		Clé hexagonale Allen key	1				
B	 M6*30	Vis Screw	10	J		Charnière Hinge	4
C		Clé hexagonale Allen key	1	L	 M3.5*15	Vis Screw	20
E		Tige de connexion Connector rod	18	M		Poignée Handle	2
F		Came Cam	18	N		Patte Leg	2
G		Rondelle Washer	18	K		Patte Leg	2
H		Goujon Dowel	12	B1	 M6*15	Vis Screw	8

Connectez 1 x patte (K) et 1 x patte (N) à l'aide de 4 x vis (B1) et de 4 x rondelle (G). Serrez avec la clé hexagonale (A). Répétez. une autre fois.

Connect 1 x leg (K) and 1 x leg (N) using 4 x screw (B1) and 4 x washer (G). Tighten with the Allen key (A). Repeat another time.

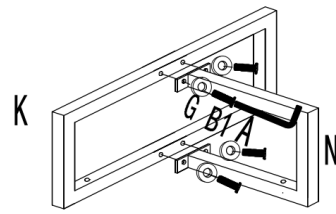

2

Fixez le panneau inférieur (O) au cadre assemblé à l'étape 1 à l'aide de 6 x vis (B) et de 6 x rondelle (G). Serrez avec la clé hexagonale (A).

Attach the bottom panel (O) to the frame assembled in step 1 using 6 x screw (B) and 6 x washer (G). Tighten with the Allen key (A).

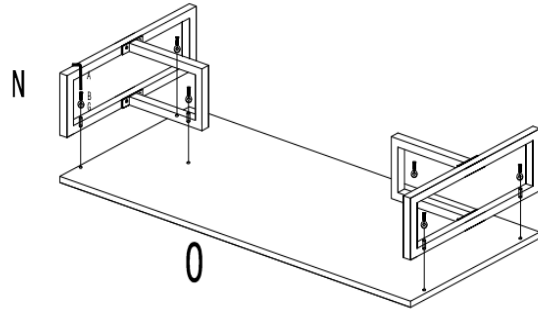

3

Caution: Do not over tighten the bolts.

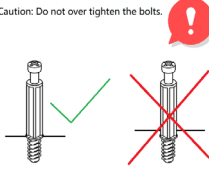

Connectez 2 x panneau latéral (P) et 1 x panneau inférieur (O) à l'aide de 6 x tige de connexion (E), 6 x came (F) et de 4 x goujon (H).

Connectez 1 x panneau central (R) à 1 x panneau inférieur (O) à l'aide de 3 x tige de connexion (E), 3 x came (F) et 2 x goujon (H).

Placez 9 x tige de connexion (E) et 6 x goujon (H) dans les trous du panneau supérieur (S) et connectez avec la structure assemblée dans cette étape à l'aide de 9 x came (F).

Connect 2 x side panel (P) and 1 x bottom panel (O) using 6 x connector rod (E), 6 x cam (F) and 4 x dowel (H).

Connect 1 x middle panel (R) to 1 x bottom panel (O) using 3 x connector rod (E), 3 x cam (F) and 2 x dowel (H).

Place 9 x connector rod (E) and 6 x dowel (H) in the top panel (S) holes and connect with the structure assembled in this step using 9 x cam (F).

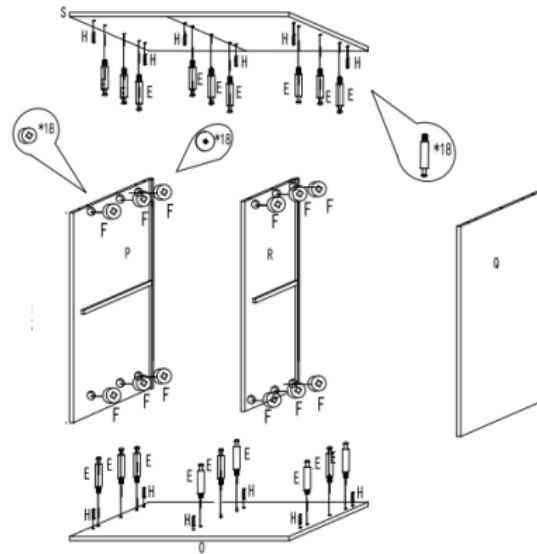

4

Utilisez la clé hexagonale (C) pour relier 2 x panneau arrière (T) à 2 x panneau latéral (P) et 1 x panneau central (R) avec 20 x vis (L).

Use the Allen key (C) to connect 2 x back panel (T) to 2 x side panel (P) and 1 x middle panel (R) with 20 x screw (L).

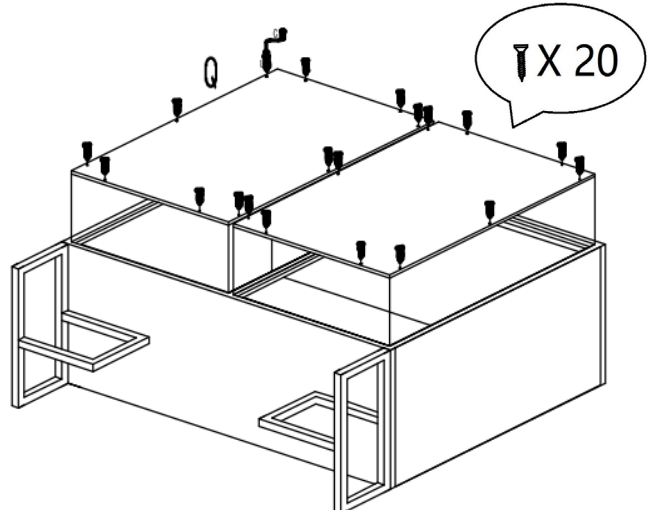

5

Reliez 4 x charnière (J) à 2 x porte (X) à l'aide de 8 x vis (L) (provenant du sac de charnières). Serrez avec la clé hexagonale (C).

Connect 4 x hinge (J) to 2 x door (X) using 8 x screw (L) (from the hinge bag). Tighten with the Allen key (C).

Attention:

Properly aligned the hinges is critical for the door alignment and smooth opening. It is important to follow below instructions:

Lay the door face down on a clean, flat surface with the hinge-side facing up;

Place the hinge on the door and mark the distance 1.06"(27mm) from the edge with pencil, to ensure the position where will bore your hole;

80% tighten the screws for further adjustment and connect the door to the cabinet;

100% tighten the screw once the door is proper positioned

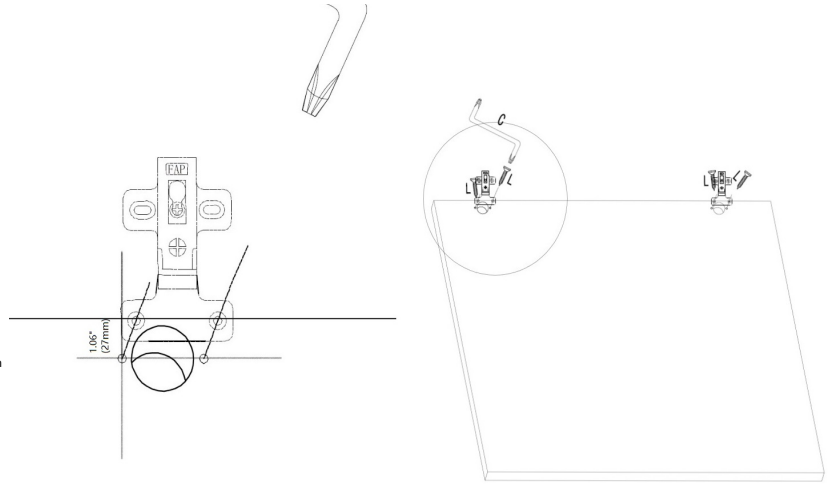

6

Fixez 2 x porte (X) à l'armoire en utilisant 8 x vis (L). Serrez avec la clé hexagonale (C).

Attach 2 x door (X) to the cabinet using 8 x screw (L). Tighten with the Allen key (C).

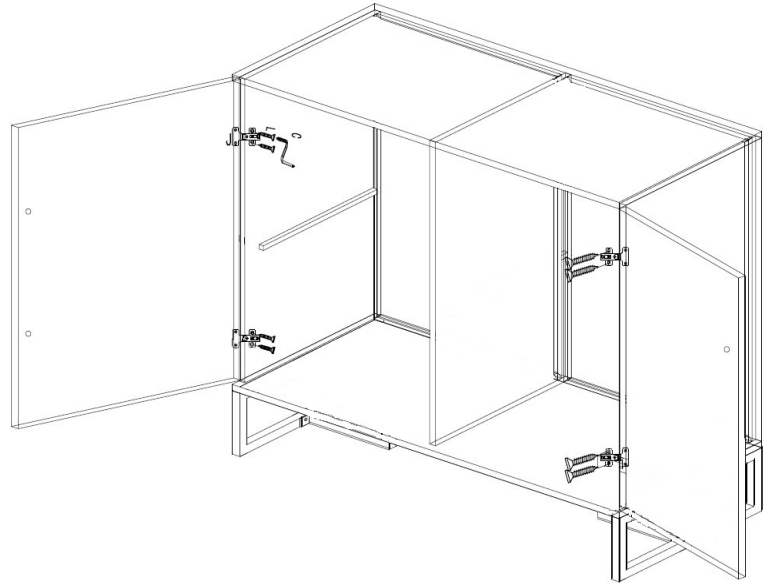

7

Placez 2 x Panneau d'étagère (Q) à l'intérieur du buffet.  
Put 2 x Shelf panel (Q) inside the cabinet.

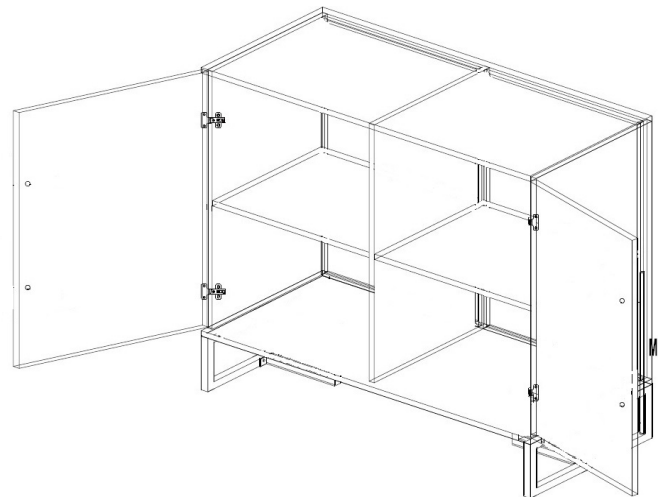

8

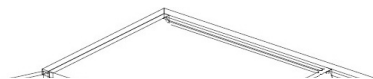

Fixez 2 x poignée (M) au cadre assemblé à l'étape 6 à l'aide de 4 x vis (B) et de 4 x rondelle (G).  
Serrez avec un tournevis Serrez avec la clé Allen (C)

Attach 2 x handle (M) to the frame assembled in step 6 using 4 x screw (B) and 4 x washer (G).  
Tighten with the Allen key (A).

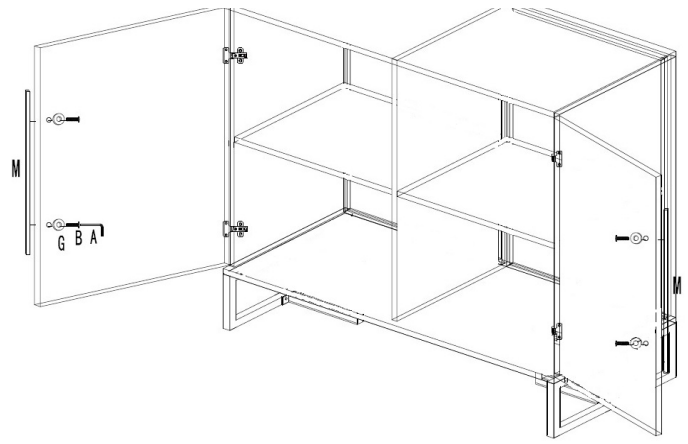

7

Article assemblé.

Item assembled.

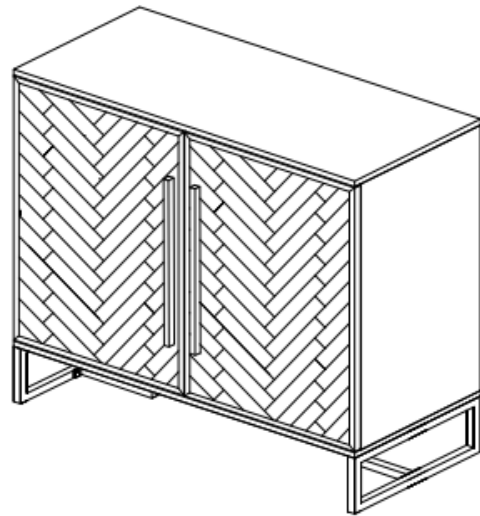

Questions? [customerservice@bouclair.com](mailto:customerservice@bouclair.com) / 1 800 268-2524