

# INSTRUCTIONS D'INSTALLATION

## Store à rouler en toile sans cordon

GRANDEURS :	SUPPORTS	VIS	DISPOSITIFS D'ANCRAGE EN PLASTIQUE	OUTILS SUGGÉRÉS :
<48"	2X	6X	6X	PERCEUSE TOURNEVIS PHILLIPS
>=48"	3X	9X	9X	

**1** Choisir l'emplacement du store, puis installer les supports

**a.** À l'intérieur du cadre de la fenêtre

**b.** Sur le cadre de la fenêtre

**c.** Au plafond

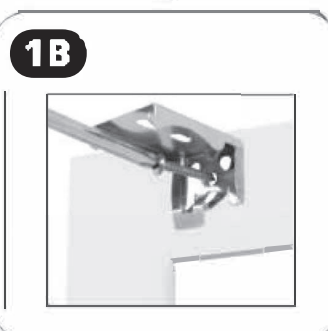
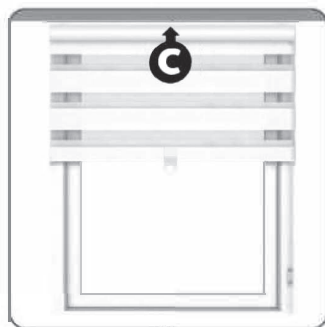
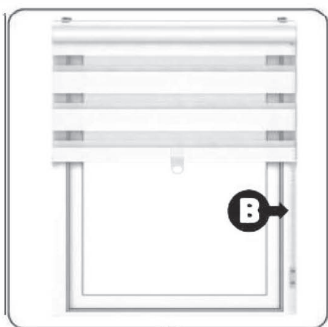

**NOTE:** Des vis sont fournies pour l'installation sur des cadres de bois seulement. Pour les panneaux muraux ou les murs de plâtre, utiliser les dispositifs d'ancrage en plastique ci-joints. Pour les autres surfaces comme le métal ou le béton, veuillez utiliser les vis et la quincaillerie appropriées.

**2** Installez le store sur les supports.











Pousser jusqu'à entendre un « clic ».

**3** Les poignées en plastique doivent être au milieu. Puis, baissez doucement les rideaux.



# INSTALLATION INSTRUCTIONS

## Cordless Sheer Shade

SIZES:	BRACKETS	SCREWS	PLASTIC WALL ANCHORS	SUGGESTED TOOLS:
<48"	 2X	 6X	 6X	 DRILL
>=48"	 3X	 9X	 9X	 PHILLIPS HEAD SCREWDRIVER

**1** Decide where to hang the blind and install the brackets.

a. Inside the frame of the window

b. On the frame of the window

c. On the ceiling

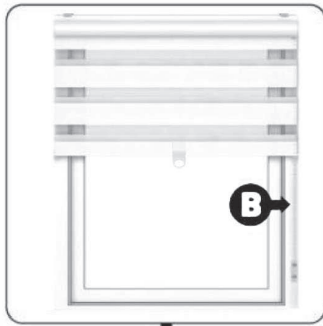

**NOTE:** Screws are provided for installation into wooden frames only. For wallboard or plaster, use the included plastic wall anchors. For other surfaces such as metal or concrete, please purchase appropriate screws and hardware.

**2** install the blind on brackets.



Install the blind on brackets. Push until you hear the "click" sound.

**3** Plastic handle must be in the middle. Then, pull the shade up or down gently.

