

# Bouclair

## INSTRUCTIONS D'ASSEMBLAGE

## ASSEMBLY INSTRUCTIONS

Style  
**9405212**

Il s'agit du numéro principal pour toutes les questions.  
This is the main number concerning all questions.

**1-800-268-2524**

**serviceclientele@bouclair.com**

**customerservice@bouclair.com**

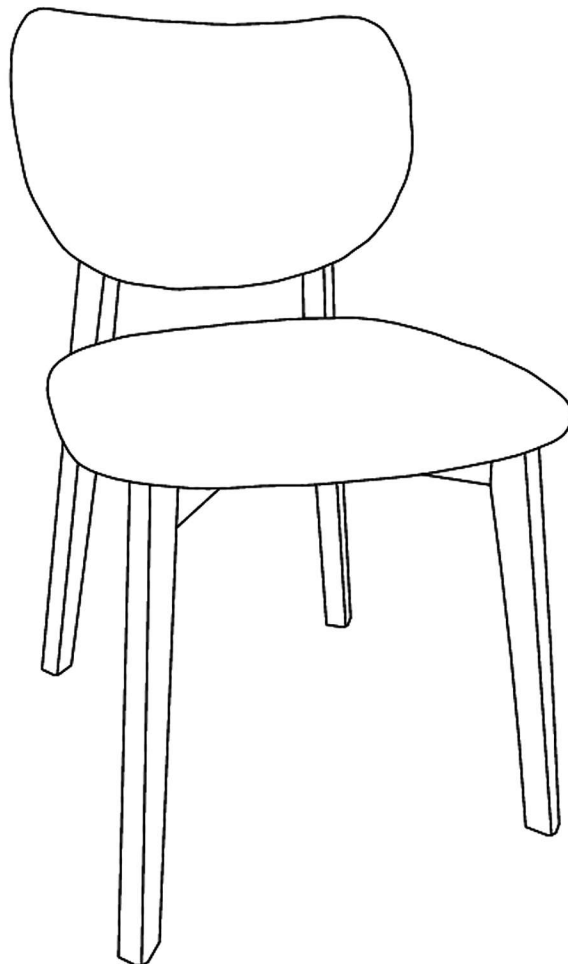

**DOIT ÊTRE ASSEMBLÉ PAR UN ADULTE**  
**ADULT ASSEMBLY REQUIRED**

## IMPORTANT

- Nous vous suggérons de lire ce dépliant jusqu'au bout et de suivre les instructions simples étape par étape.
- Vérifiez soigneusement que vous avez toutes les pièces avant de commencer l'assemblage.
- Gardez les pièces de fixation hors de la portée des enfants et tenir les enfants bien éloignés de la zone d'assemblage.
- Nous recommandons d'utiliser l'emballage afin de protéger les surfaces pendant l'assemblage.
- Manipulez les pièces avec soin pendant l'assemblage pour éviter les égratignements.

## IMPORTANT

- We suggest you read through this leaflet and follow these simple step-by-step instructions.
- Unpack carefully and check that you have all parts before beginning assembly.
- Keep fittings out of children reach and keep children well away from the assembly area.
- We recommend using the packaging to protect the product during assembly.
- Handle all components with care during assembly to prevent from scratching.

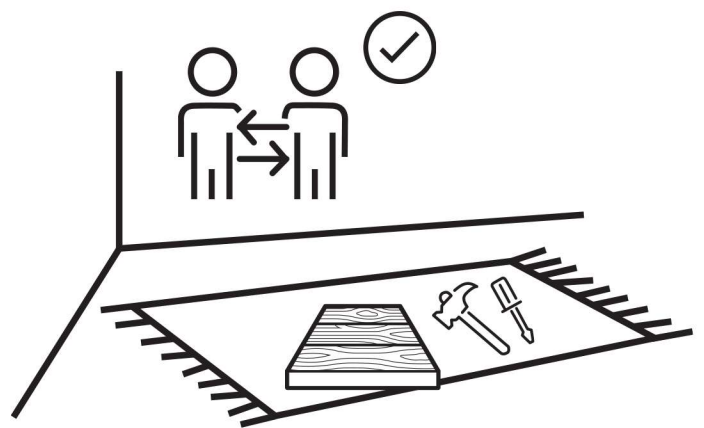
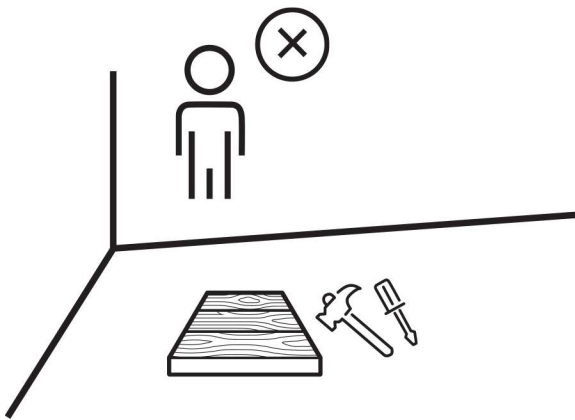

## OUTILS REQUIS / TOOLS REQUIRED

- Les outils nécessaires à l'assemblage sont fournis.
- The assembly tools are provided.

- N'utilisez pas de perceuse pour assembler cet article

- Do not use a drill to assemble this article.



# MATÉRIEL INCLUS INCLUDED HARDWARE

**1X**

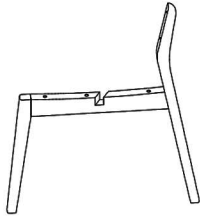

**#1**

**1X**

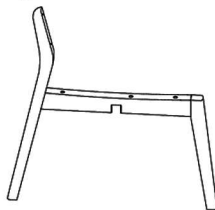

**#2**

**1X**

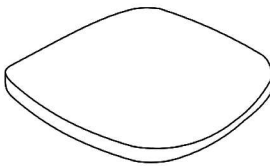

**#3**

**1X**

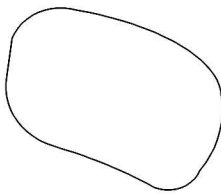

**#4**

**4X**



*M6x30mm*

**#5**

**6X**

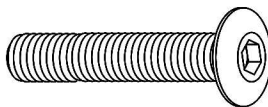

*M6x70mm*

**#6**

**10X**

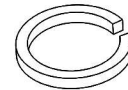

*M6x10mm*

**#7**

**10X**

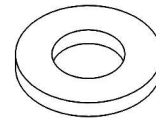

*M6x12mm*

**#8**

**1X**



*M6*

**#9**

**1X**

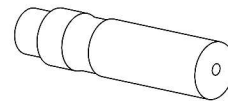

*Colle / Glue*

**#10**

**4X**

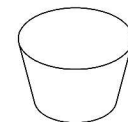

*13mm*

**#11**

# ÉTAPES D'ASSEMBLAGE ASSEMBLY STEPS

# 1

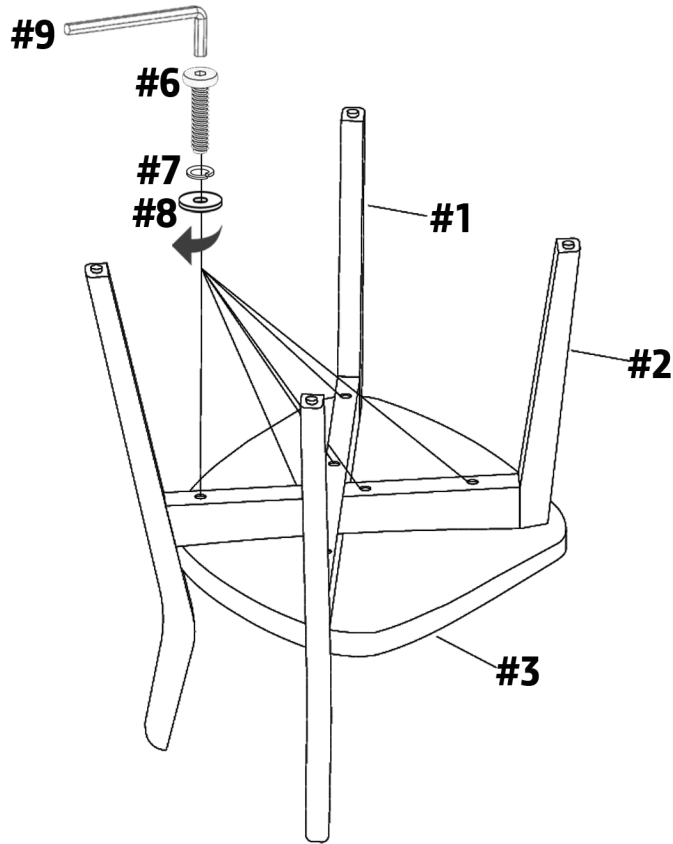

6X		#6
6X		#7
6X		#8
1X		#9

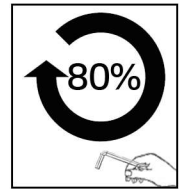

# 2

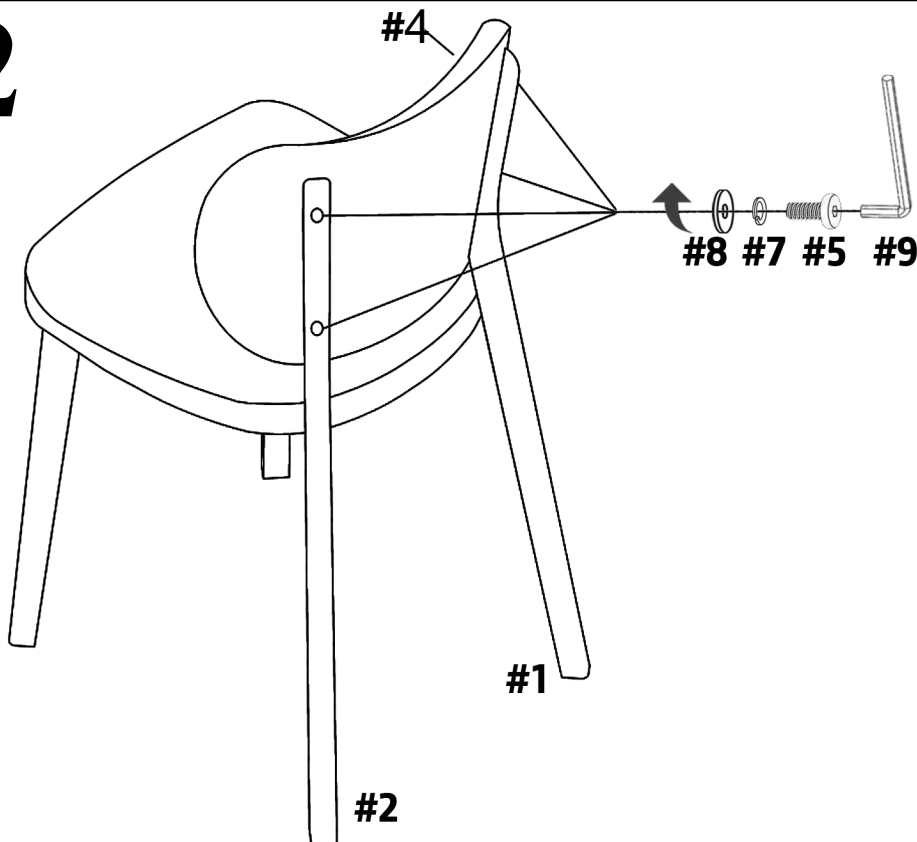

4X		#5
4X		#7
4X		#8
1X		#9

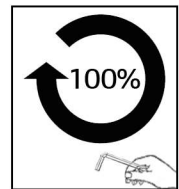

# ÉTAPES D'ASSEMBLAGE ASSEMBLY STEPS

# 3

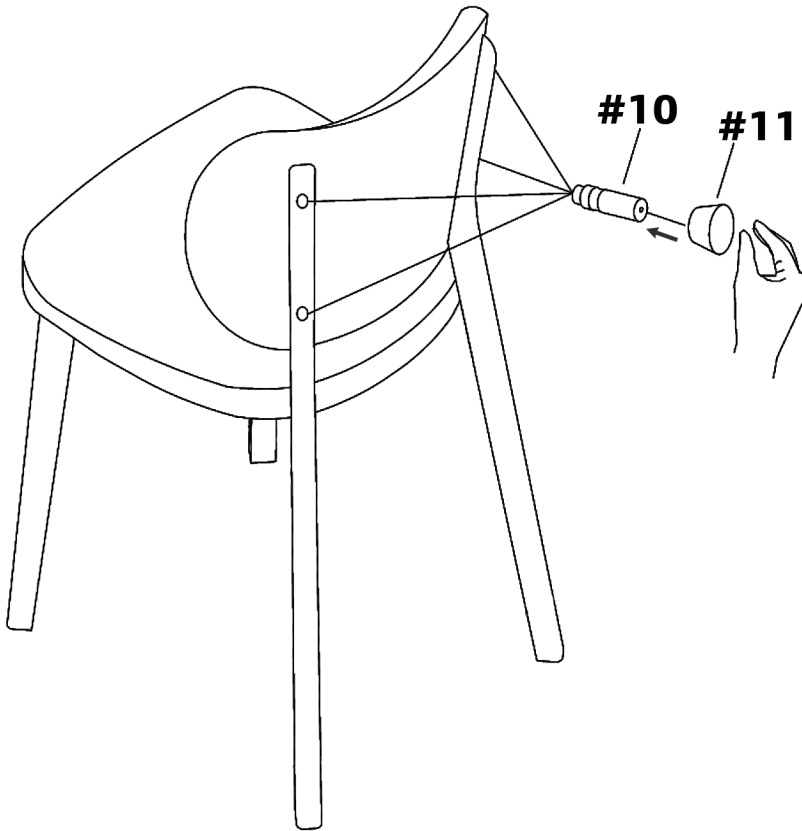

1X



#10

4X



#11

# 4

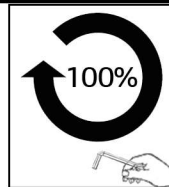

**Serrez toutes les vis 100%**  
**Tighten all Screws 100%**

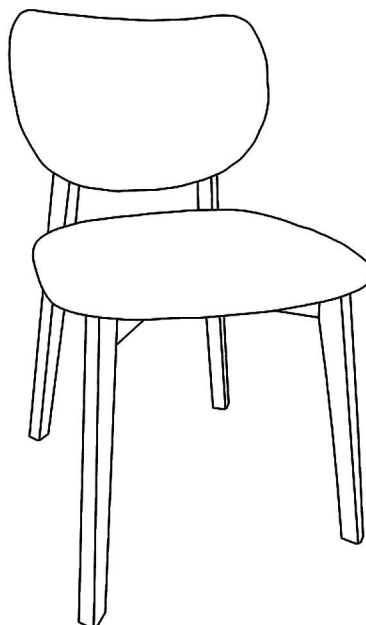

# ÉTAPES D'ASSEMBLAGE ASSEMBLY STEPS

**5**

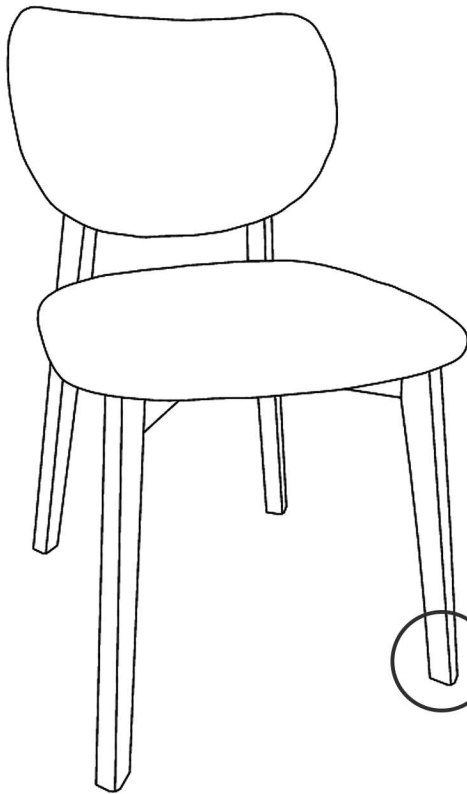

**Ajustez les pieds réglables  
à un état stable.  
Adjust the adjustable feet  
to a stable status.**

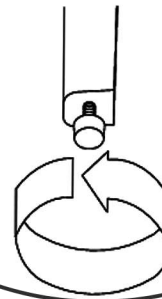

# CONSEILS D'ENTRETIEN

## MAINTENANCE TIPS



- Ne laissez jamais de liquides ou de chiffons humides toucher la surface de ce meuble.
- Never let liquids or damp cloths sit on this furniture.



- N'utilisez jamais de produits nettoyants chimiques, car ils peuvent endommager la finition.
- Never use chemical cleaning products. They can damage the finish.

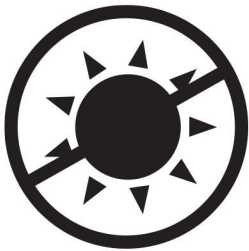

- Pour ne pas ternir la finition, évitez de placer le meuble en plein soleil.
- To avoid dulling the finish, do not place furniture in direct sunlight.



- Utilisez un chiffon doux ou légèrement humide pour nettoyer, puis essuyez avec un chiffon propre et sec.
- Use a soft or slightly damp cloth to clean, then wipe with a clean, dry cloth.