

# Bouclair

## INSTRUCTIONS D'ASSEMBLAGE

### ASSEMBLY INSTRUCTIONS

Style  
9409042

Il s'agit du numéro principal pour toute question.  
This is the main number for all inquiries.



1-800-268-2524

[serviceclientele@bouclair.com](mailto:serviceclientele@bouclair.com)

[customerservice@bouclair.com](mailto:customerservice@bouclair.com)

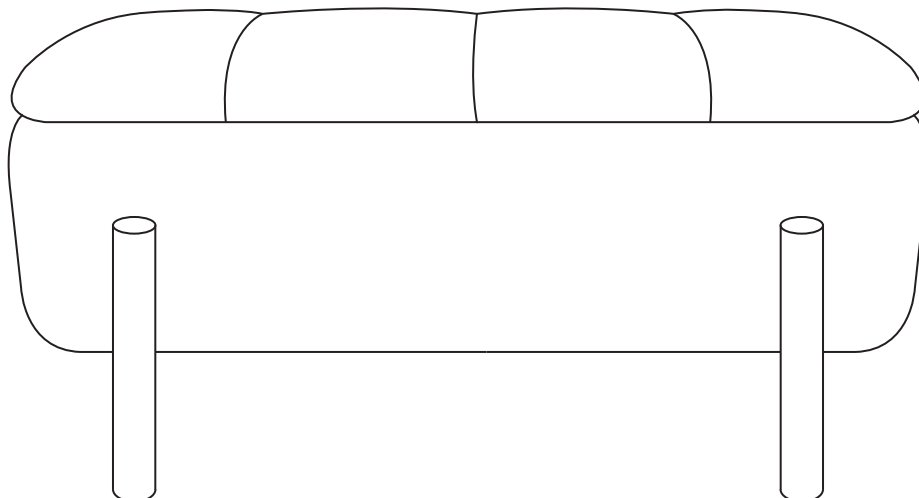

**A** DOIT ÊTRE ASSEMBLÉ PAR UN ADULTE  
ADULT ASSEMBLY REQUIRED

## IMPORTANT

Nous vous suggérons de lire ce dépliant jusqu'au bout et de suivre les instructions simples étape par étape.

Vérifiez soigneusement que vous avez toutes les pièces avant de commencer l'assemblage.

Gardez les pièces de fixation hors de la portée des enfants et tenir les enfants éloignés de la zone d'assemblage.

Nous recommandons d'utiliser l'emballage afin de protéger les surfaces pendant l'assemblage.

Manipulez les pièces avec soin pendant l'assemblage pour éviter les égratignures.

## IMPORTANT

We suggest you read through this leaflet and follow these simple step-by-step instructions.

Unpack carefully and check that you have all parts before beginning assembly.

Keep fittings out of children reach and keep children well away from the assembly area.

We recommend using the packaging to protect the product during assembly.

Handle all components with care during assembly to prevent from scratching.

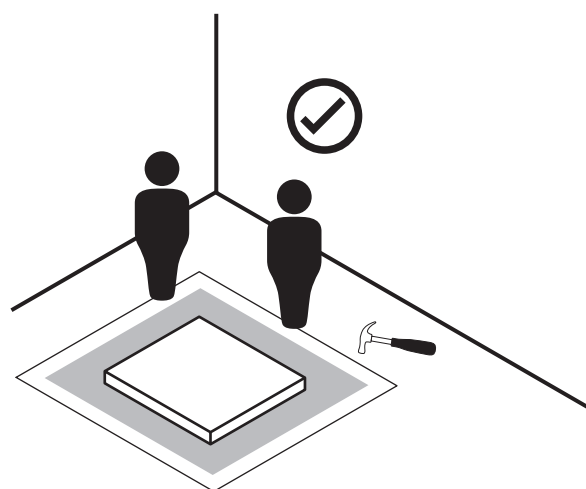
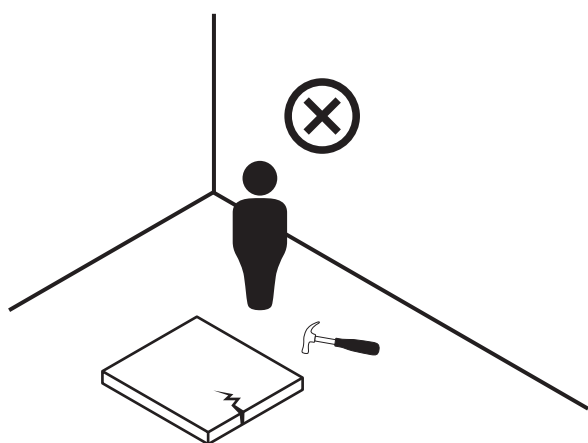

## OUTILS REQUIS / TOOLS REQUIRED

- Les outils nécessaires à l'assemblage sont fournis.
- Assembly tools are provided

**N'utilisez pas de perceuse pour assembler cet article.**

**Do not use a drill to assemble this article.**



# MATÉRIEL INCLUS INCLUDED HARDWARE

8x



#1

8x



#2

1x

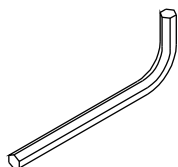

#3

1x

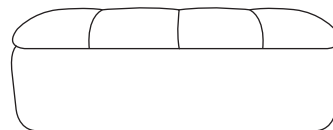

A

4x

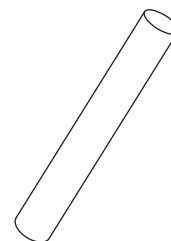





B

# ÉTAPES D'ASSEMBLAGE

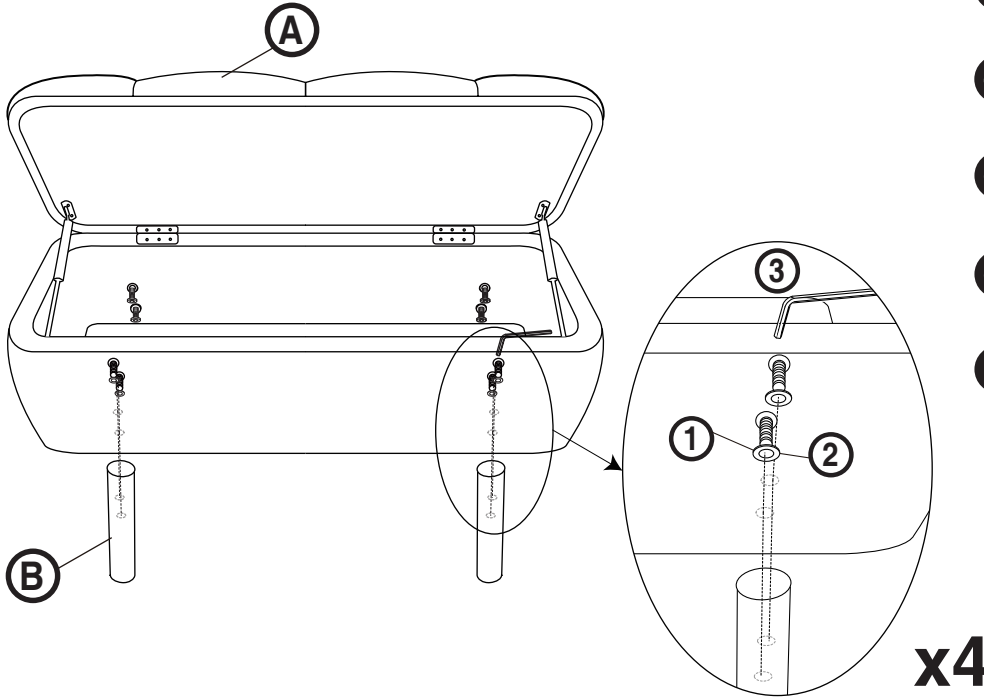
## ASSEMBLY STEPS

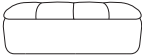
# 1



- 1x  **A**
- 4x  **B**
- 8x  **#1**
- 8x  **#2**
- 1x  **#3**

# 2

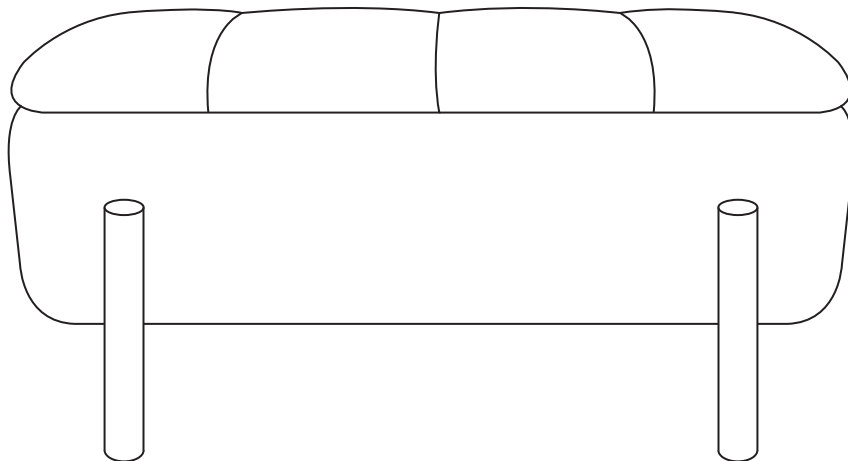

## CONSEILS D'ENTRETIEN MAINTENANCE TIPS



**Ne laissez jamais de liquides ou de chiffons humides toucher la surface de ce meuble.**

**Never let liquids or damp cloths sit on this furniture.**



**N'utilisez jamais de produits nettoyants chimiques, car ils peuvent endommager la finition.**

**Never use chemical cleaning products. They can damage the finish.**



**Pour ne pas ternir la finition, évitez de placer le meuble en plein soleil.**

**To avoid dulling the finish, do not place furniture in direct sunlight.**



**Utilisez un chiffon doux et légèrement humide pour nettoyer, puis essuyez avec un chiffon propre et sec.**

**Use a soft or slightly damp cloth to clean, then wipe with a clean, dry cloth.**