

# Bouclair

## INSTRUCTIONS D'ASSEMBLAGE

### ASSEMBLY INSTRUCTIONS

Style  
9407249

Il s'agit du numéro principal pour toute question.  
This is the main number for all inquiries.



1-800-268-2524

[serviceclientele@bouclair.com](mailto:serviceclientele@bouclair.com)

[customerservice@bouclair.com](mailto:customerservice@bouclair.com)

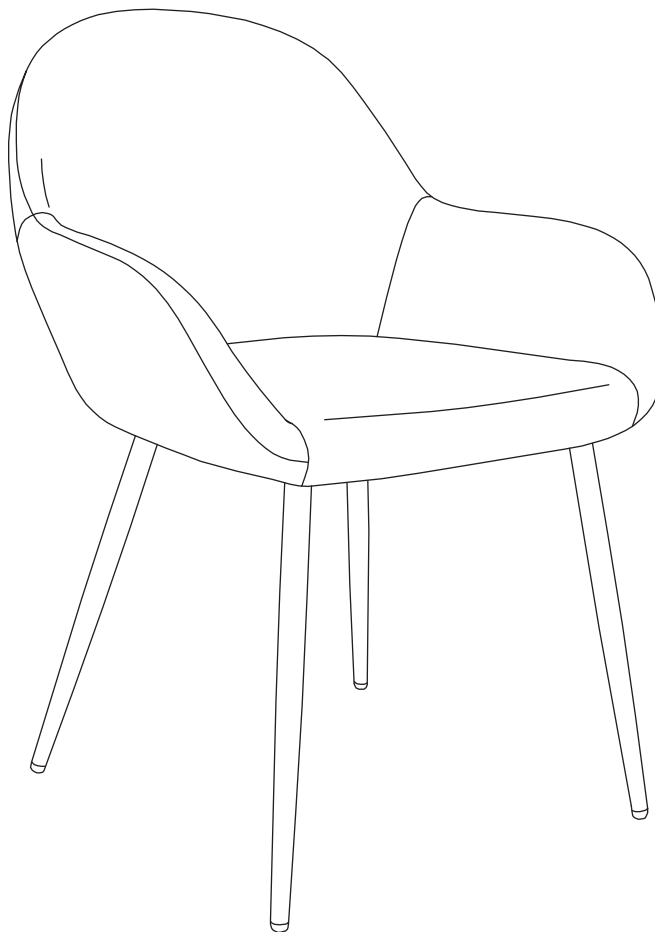

**A** DOIT ÊTRE ASSEMBLÉ PAR UN ADULTE  
ADULT ASSEMBLY REQUIRED

## IMPORTANT

- Nous vous suggérons de lire ce dépliant jusqu'au bout et de suivre les instructions simples étape par étape.
- Vérifiez soigneusement que vous avez toutes les pièces avant de commencer l'assemblage.
- Gardez les pièces de fixation hors de la portée des enfants et tenir les enfants éloignés de la zone d'assemblage.
- Nous recommandons d'utiliser l'emballage afin de protéger les surfaces pendant l'assemblage.
- Manipulez les pièces avec soin pendant l'assemblage pour éviter les égratignures.

## IMPORTANT

- We suggest you read through this leaflet and follow these simple step-by-step instructions.
- Unpack carefully and check that you have all parts before beginning assembly.
- Keep fittings out of children reach and keep children well away from the assembly area.
- We recommend using the packaging to protect the product during assembly.
- Handle all components with care during assembly to prevent from scratching.

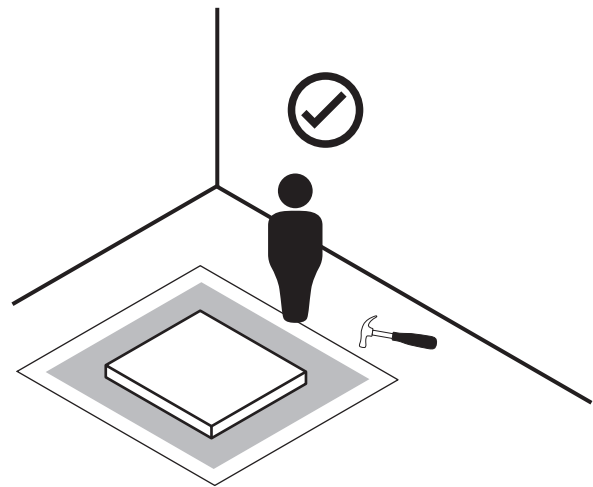
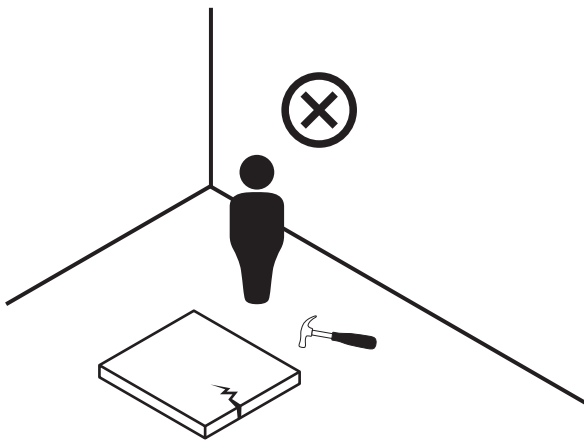

## OUTILS REQUIS / TOOLS REQUIRED

- **Les outils nécessaires à l'assemblage sont fournis.**
- **Assembly tools are provided**

**N'utilisez pas de perceuse pour assembler cet article.**

**Do not use a drill to assemble this article.**



# MATÉRIEL INCLUS INCLUDED HARDWARE

1x

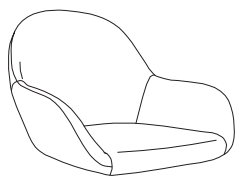

A

1x

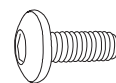

D

1x

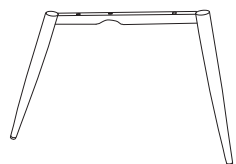

B

4x

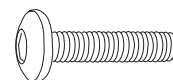

E

1x

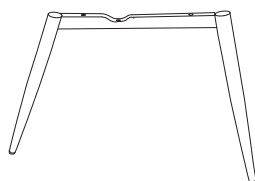

C

1x





L

# ÉTAPES D'ASSEMBLAGE

## ASSEMBLY STEPS

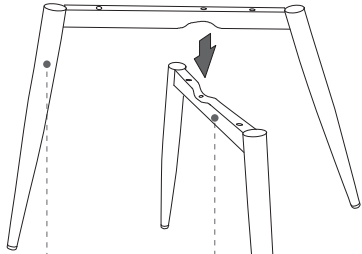
# 1



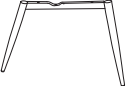

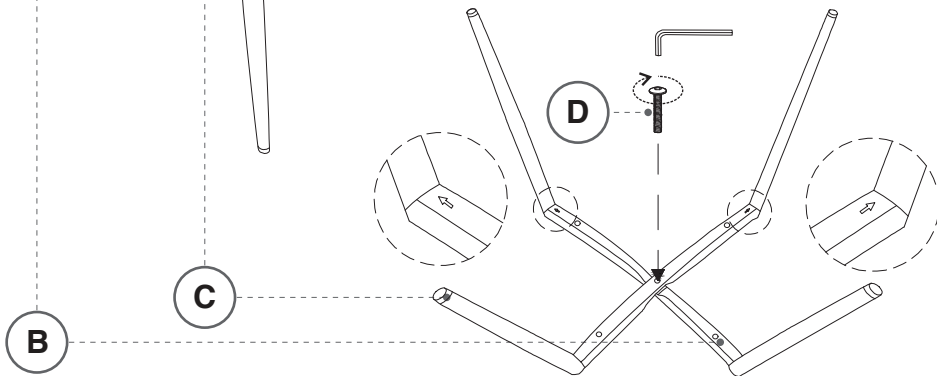
- 1x  D
- 1x  B
- 1x  C

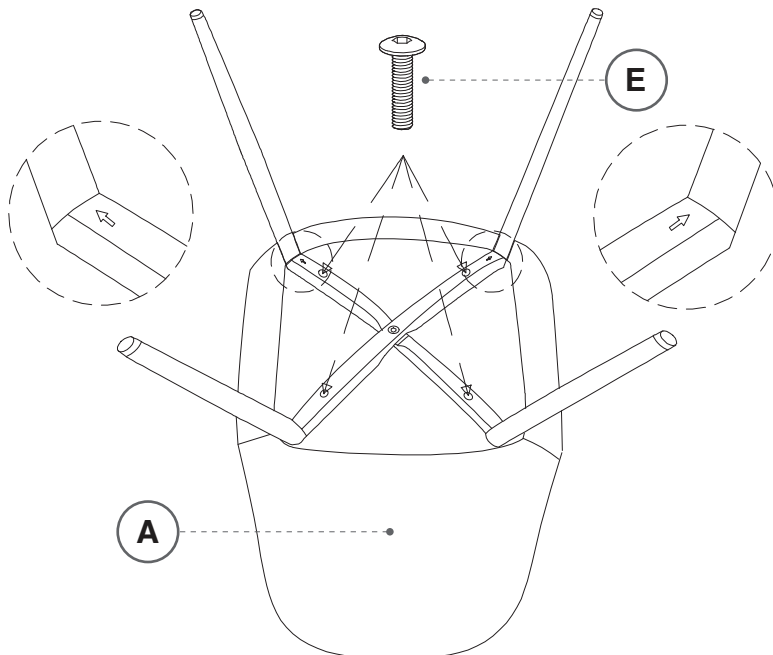

# 2



- 1x  A
- 4x  E

# ÉTAPES D'ASSEMBLAGE ASSEMBLY STEPS

# 3



## CONSEILS D'ENTRETIEN MAINTENANCE TIPS



- Ne laissez jamais de liquides ou de chiffons humides toucher la surface de ce meuble.
- Never let liquids or damp cloths sit on this furniture.



- N'utilisez jamais de produits nettoyants chimiques, car ils peuvent endommager la finition.
- Never use chemical cleaning products. They can damage the finish.



- Pour ne pas ternir la finition, évitez de placer le meuble en plein soleil.
- To avoid dulling the finish, do not place furniture in direct sunlight.



- Utilisez un chiffon doux et légèrement humide pour nettoyer, puis essuyez avec un chiffon propre et sec.
- Use a soft or slightly damp cloth to clean, then wipe with a clean, dry cloth.